



*This fixture must be installed and wired by a licensed electrician.

*JLC-Tech LLC will not be held responsible if the fixtures are not installed according to applicable codes and safety standards

*Installation is subject to local code and jurisdiction

*Keep these instructions for the person responsible for the maintenance of this installation.

Electrical Ratings

Input Voltage: 120-277V, 50/60Hz

Refer to product label for model specific wattage ratings

ETL Listed for Indoor Use

ATTENTION: READ ALL INSTRUCTIONS ENTIRELY BEFORE INSTALLATION

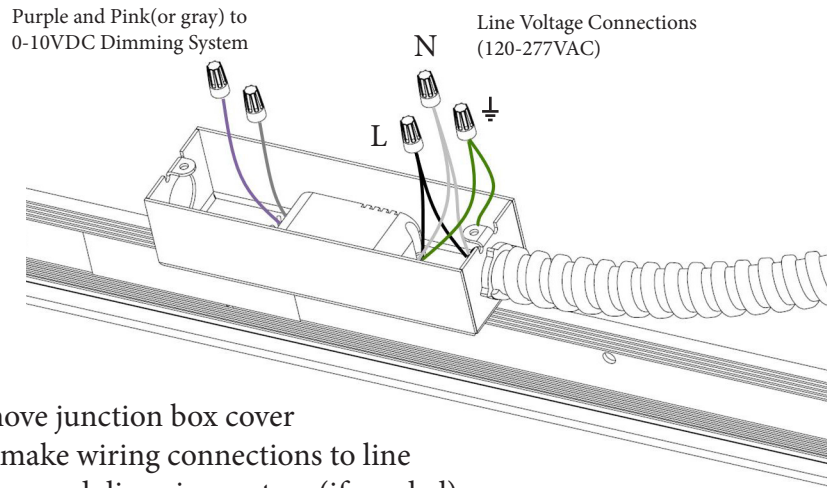

Remove junction box cover and make wiring connections to line voltage and dimming system (if needed). Replace cover when complete.

ATTENTION: READ ALL INSTRUCTIONS ENTIRELY BEFORE INSTALLATION



THE ONLY LIGHTING PRODUCTS THAT ARE ENGINEERED AND PATENTED TO REPLACE THE CROSS MEMBERS IN A SUSPENDED GRID CEILING SYSTEM.

FOR MODELS:

- DIFFUSING LENS
- BLOCK LENS
- DIFFUSE WHITE LENS

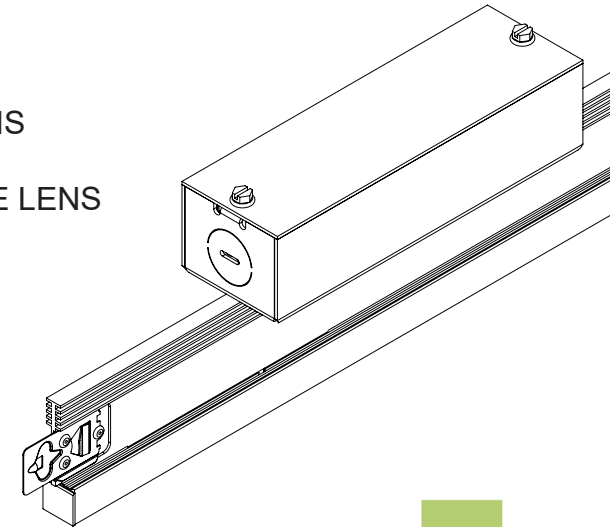

SPECIFICALLY DESIGNED FOR USE WITH ARMSTRONG 9/16" DESIGNFLEX™ CEILING SYSTEM



DESIGNflex®
A New World of Choice
for Ceiling Systems



For patent information see: www.jlc-tech.com/patents

MADE IN USA

CODE: T-BAR398 T-BAR FLEX Instruction Sheet 9/16" Rev:04

WHERE I CAN INSTALL THE T-BAR FLEX®

- IN A NEW 9/16" (T15) DESIGNFLEX™ CEILING GRID INSTALLATION, THE ACOUSTICAL CONTRACTOR (AC) WILL INSTALL THE ARMSTRONG CEILING GRID IN THE SPECIFIED PATTERN, LEAVING SPECIFIC OPENINGS FOR THE ELECTRICAL CONTRACTOR (EC), ACCORDING TO THE LIGHT REQUIREMENT
- THE EC WILL INSTALL THE APPROPRIATE SIZE T-BAR FLEX® AT THE SPECIFIC OPENING IN THE CEILING

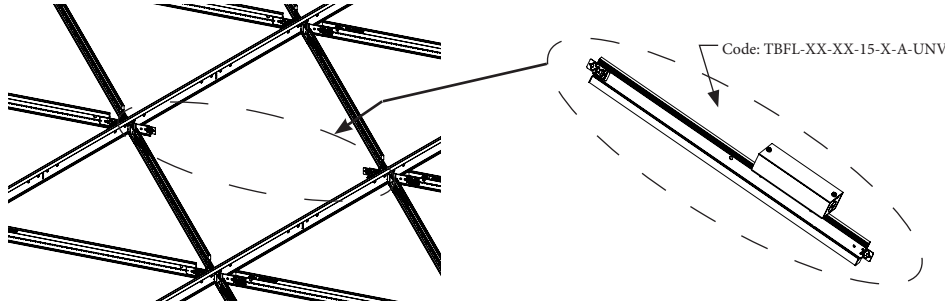

- AFTER THE EC HAS PROPERLY COMPLETED THE INSTALLATION, THE AC WILL FINISH THE CEILING WITH APPROPRIATE SIZE CEILING TILES

- IN AN EXISTING SUSPENDED 9/16" (T15) GRID, VERIFY THE EXISTING CEILING IS AN ARMSTRONG DESIGNFLEX™ CEILING, THEN LOCATE THE CROSS TEES THAT ARE INTENDED TO BE SUBSTITUTED WITH THE APPROPRIATE SIZE T-BAR FLEX® (ACCORDING TO THE LIGHT REQUIREMENT)
- THE AC SHALL TEMPORARILY REMOVE THE TILES WITHIN THE SPACE SELECTED AND REMOVE THE CROSS TEES
- THE EC SHALL THEN INSTALL THE CORRECT SIZE T-BAR FLEX® IN THIS DESIRED LOCATION
- AFTER THE EC HAS PROPERLY COMPLETED THE INSTALLATION, THE AC WILL REINSTALL THE EXISTING OR REPLACEMENT CEILING TILES

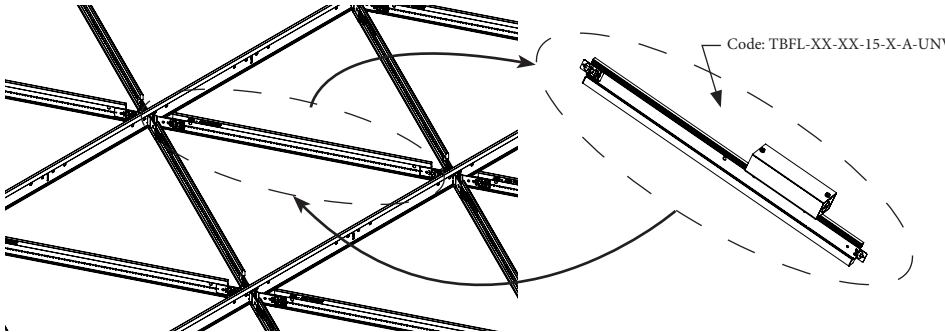

NOTE: WHEN CORRECTLY INSTALLED THE END DETAILS WILL ENSURE THE T-BAR FLEX® IS POSITIONED CORRECTLY ALLOWING FOR THE CORRECT SPACING OF THE ARMSTRONG CEILING TILES

NOTE: THE T-BAR FLEX® HAS BEEN SEISMICALLY TESTED FOR USE WITH ARMSTRONG DESIGNFLEX™ CEILINGS AND **DOES NOT NEED** TO BE INDEPENDENTLY SUPPORTED

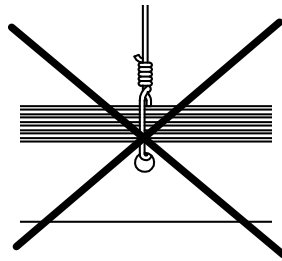
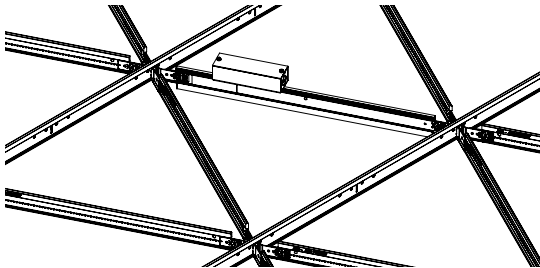

HOW I INSTALL THE T-BAR FLEX®

- THE T-BAR FLEX® IS INSTALLED WITH A STAB CONNECTION TO THE DESIGNFLEX™ ANGLE BRACKET. THESE CONNECTIONS ARE ONLY COMPATIBLE WITH THE BRACKETS.
- CONNECT THE XM END DETAILS OF THE T-BAR FLEX® WITH THE XM END DETAILS OF THE BRACKET (1)
- ENSURE THE OVERRIDES ON THE BRACKETS ARE FLUSH WITH THE T-BAR FLEX® (2)

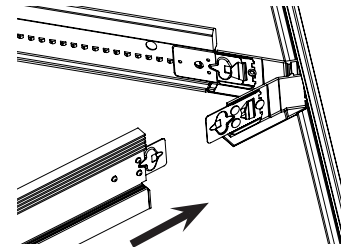

(1)

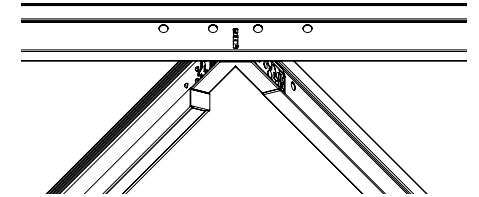

(2)

FOR INSTALLATION CONFIGURATIONS NOT DESCRIBED ABOVE PLEASE CONSULT FACTORY

- AFTER THE EC HAS ELECTRIFIED THE T-BAR FLEX® (SEE FOLLOWING PAGE FOR INSTRUCTION), THE AC CAN INSTALL THE ARMSTRONG CEILING TILES IN THEIR CORRECT POSITION OVER THE T-BAR FLEX® PRODUCT AS SHOWN

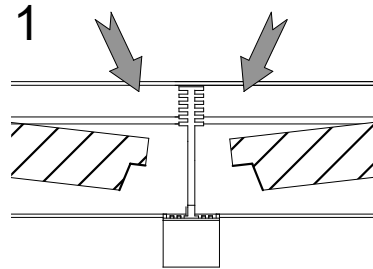

1

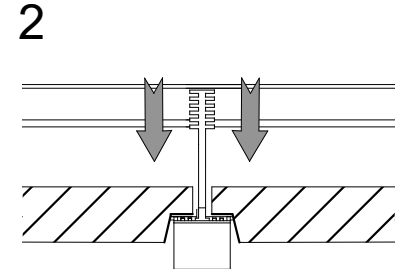

2

- THE JUNCTION BOX ON THE T-BAR FLEX® CAN BE SHIFTED TO ONE SIDE OR THE OTHER IF THERE IS ANY INTERFERENCE WITH AN HVAC REGISTER OR OTHER CEILING UTILITY.
- OPEN THE COVER ON THE JUNCTION BOX AND REMOVE THE 2 SCREWS THAT ATTACH THE JUNCTION BOX TO THE T-BAR FLEX®
- THERE IS AN ADDITIONAL SET OF MOUNTING HOLES ON EITHER SIDE OF THE ORIGINAL HOLES, SHIFT THE JUNCTION BOX TO THE DESIRED SIDE, LINE THE HOLES UP AND INSERT THE SCREWS.

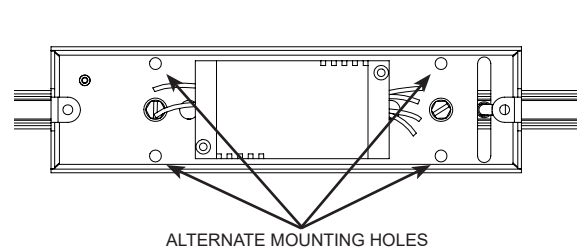

ALTERNATE MOUNTING HOLES

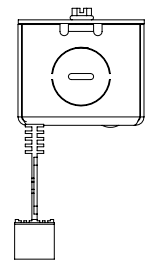

ATTENTION: READ ALL INSTRUCTIONS ENTIRELY BEFORE INSTALLATION

ATTENTION: READ ALL INSTRUCTIONS ENTIRELY BEFORE INSTALLATION